

Article number: 203180M1043B4X
 Description: E+G levelling foot
 GN 31-80-M10-43-B4-X
 Note: X With female thread, External hexagon

Measures

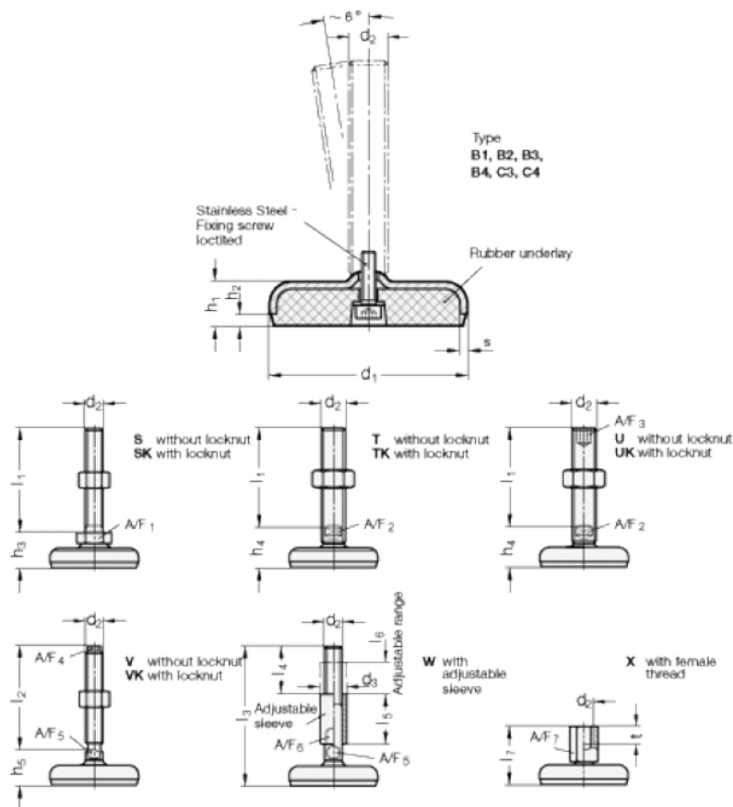

A/F7	= 14
d1	= 80
d2	= 10
h1	= 18
h2	= 5
l7 +4.0/0	= 43
s	= 3
t	= 10